

Through Beam Photoelectric Beam Sensor IR-2000TS

Features:

- Sensing Range: 20 meters
- IP-66 Water Proof
- N.C. / N.O. / Common Relay Output
- Terminal Block Wiring Connection
- Mounting Hardware Included
- Tamper Switch—Included
- AC / DC 12~24 Input Voltage

Application:

- Gate or Garage Door
- Overhead Doors
- Conveyor
- Door Entrance
- Parking Lot
- Alarm System
- Warehouse



Specifications:

Detection Method	Through Beam
Sensing Range	20 meters
Input Voltage	AC / DC 12 ~ 24V
Response Time	100 ms
Emitting Element	IR LED
Operation Indicator	Red LED(Rx): ON(when beam is broken) ; Green (Tx): ON
Dimensions	46(w) × 95(h) × 34(t) mm
Output Method	Relay Output
Current Consumption	Tx: 25mA / Rx: 25 mA (when beam alignment properly) Tx: 25mA / Rx: 15 mA (when beam is broken)
Contact Current	1A / 120VAC
Illumination	Lamplight < 10,000 Lux; Sunlight < 30,000Lux
Connection Method	Terminal Block
Noise Resistance	1500Vp-P / 1us
Surge Resistance	2KV / 1uS
Vibration Resistance	10-55Hz / 1.5mm, 2Hour In X.Y.Z.Phase
Housing Material	Casing: Nylon Cover: PCresin
Operating Temp.	-20°C ~ 60°C
Water Proof	IP-66
Safety Standard	CE

Included:

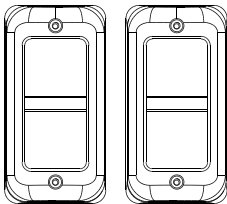

IR-2000TS



SCREWS

Part Account:

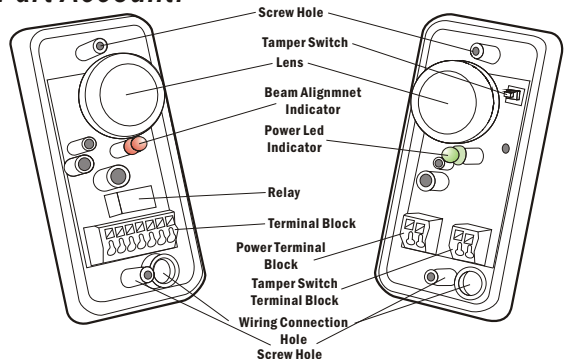

Wiring Connection:

RECEIVER

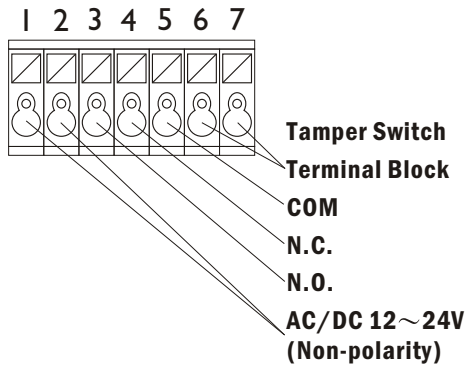

TRANSMITTER

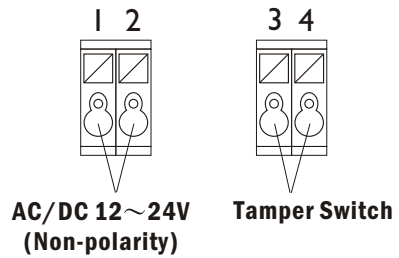

Sensing Range:

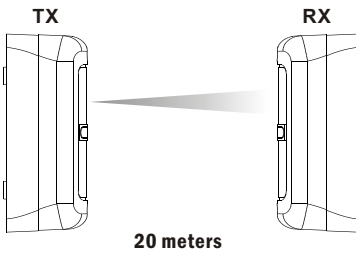

Dimensions:

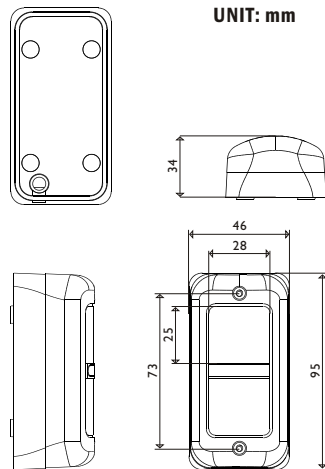

Note:

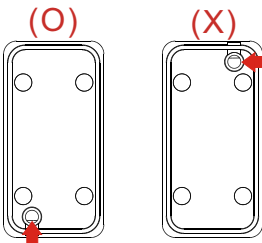

Wiring Connection

When installation, Please make sure that the hole for cable should be on the down side.